



# PFEIFER Tension Rod System

Data sheet collection

**PFEIFER**



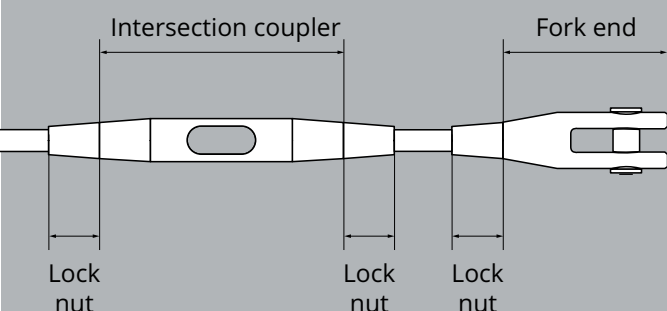
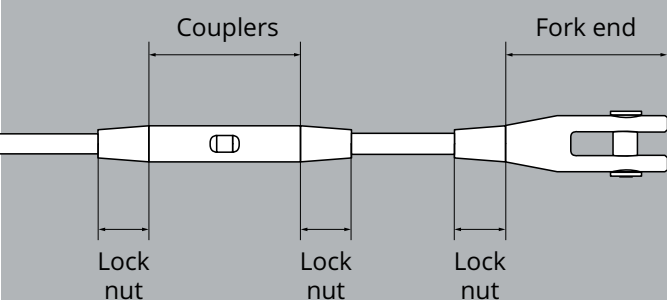
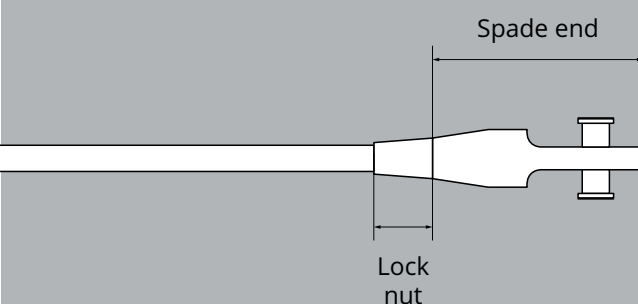
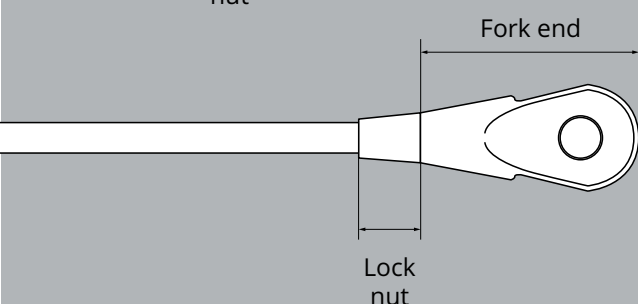
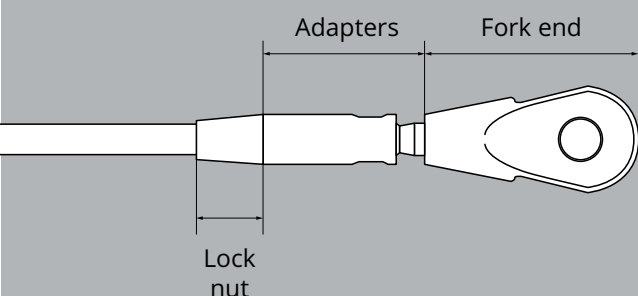

## 6

### Fork end

Fork end fittings can be connected to a simple steel gusset plate, provided by the customer and fitted between the arms of fork socket. These fittings can rotate about the axis of their pin.

## 8

### Spade end

Spade end fittings are installed to double connection plates, provided by the customer. These fittings can rotate about the axis of their pin.

## 10

### Adapters

Adapters connect directly to the fork or spade end fitting. They offer an additional length adjustment possibility in the system without having to manufacture the rod in two parts.

## 11

### Lock nut

Locknuts are added as standard to all relevant components. They secure the parts against unintentional rotation of a rod at an end fitting, and help to maintain the correct minimum screw-in depth.

## 12

### Couplers

Couplers connect split bars. Rod can be split for the reason of transportation or because of the excessive length of a rod. Couplers also provide an additional length adjustment option for the rod system.

## 13

### Intersection coupler

With an intersection coupler, two rods can cross in the same plane and they don't need an installation offset. In addition, the cross sleeve of a coupler increases the length adjustment possibilities of the system.

## 14

### Take ups

Take ups for Tension Rod Systems with fork and spade ends on both sides.



# Tension Rod UMIX



**European technical assessment:** ETA-18/0878

**Material:** According to ETA-18/0878

**Corrosion protection:** Hot-dip galvanized acc. to ISO 1461

**E modulus:** 210 kN/mm<sup>2</sup>

**Tolerance E-Modulus:** ± 10 kN/mm<sup>2</sup>

**Installation:** Please note installation manual!

**Technical details:** Spanner flats for sizes 008-048 on demand (standard: no spanner flats)!

Note system sizes 070 - 120: Limit tension differ from ETA-18/0878

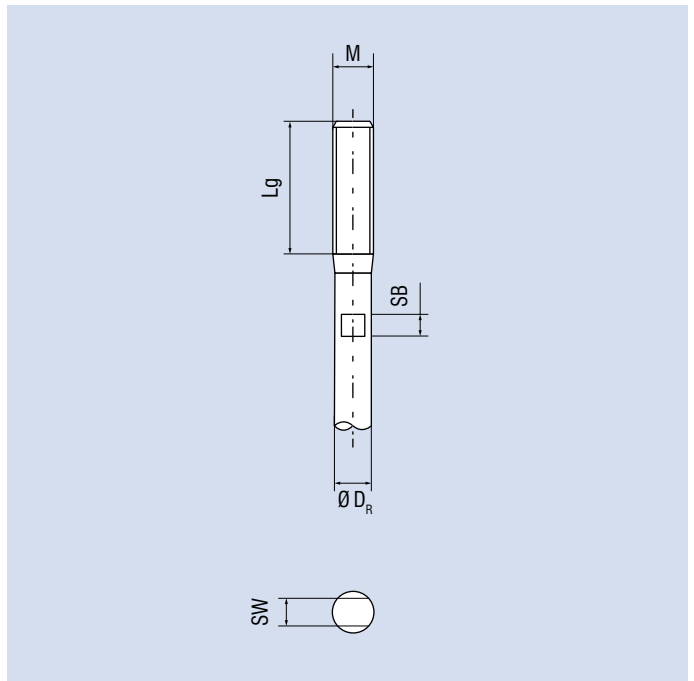

Size		008	010	012	014	016	020	024	027	030	036	042
Thread size	M	8	10	12	14	16	20	24	27	30	36	42
Spanner flat width	SB mm	12	12	12	12	16	16	16	16	20	20	20
Wrench size	SW mm	6.5	8	9.5	11	13	16.5	20	23	25	30	36
Length outer thread	Lg mm	26	33	39	48	51	65	78	88	97	116	136
Limit tension acc. EC3	Z <sub>R,d</sub> kN	19	30	43	59	80	125	180	235	286	417	573
Outer diameter	Ø D <sub>R</sub> mm	7	9	11	13	15	18	22	25	28	33	39
Weight	kg/m	0.3	0.5	0.7	1.0	1.4	2.0	3.0	3.9	4.8	6.7	9.4

Size		048	052	056	060	064	070	080	090	100	110	120
Thread size	M	48	52	56	60	64	70	80	90	100	110	120
Spanner flat width	SB mm	20	—	—	—	—	—	—	—	—	—	—
Wrench size	SW mm	41	—	—	—	—	—	—	—	—	—	—
Length outer thread	Lg mm	155	157	169	181	193	212	241	275	303	331	360
Limit tension acc. EC3	Z <sub>R,d</sub> kN	753	898	1037	1207	1367	1522	2032	2615	3272	4003	4806
Outer diameter	Ø D <sub>R</sub> mm	45	49	52	56	60	66	76	86	96	106	116
Weight	kg/m	12.5	14.8	16.7	19.3	22.2	26.9	35.6	45.6	56.8	69.3	83.0

# Fork End UMIX



**European technical assessment:** ETA-18/0878

**Installation:** Please note installation manual!

**Technical details:** Dimensions without corrosion protection!

Fatigue strength characteristics:  $N = 2\,000\,000$  load cycles;  $F_0 = 45\%$  ZBK (ZBK = characteristic breaking load of the tension rod systems);  $\Delta\sigma = 105\text{ N/mm}^2$  (detail category of tension rod systems); exposure classes 1 to 4 according to DIN EN 1993-1-11 (outdoor use, only longitudinal stress, no bending)

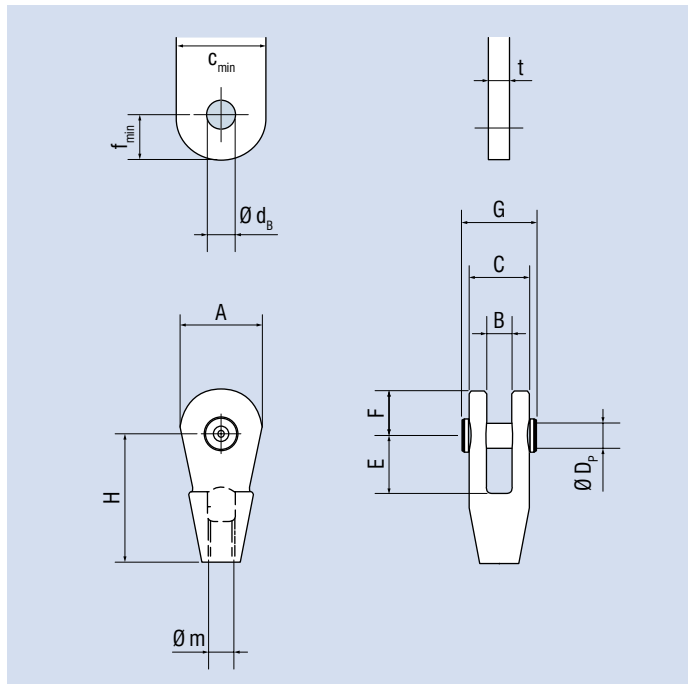

Size			008	010	012	014	016	020	024	027	030	036	042
Take-up	V	mm	± 4	± 5	± 6	± 9	± 9	± 11	± 14	± 16	± 17	± 21	± 25
Min. screw-in length		mm	13	17	20	23	25	32	38	42	47	56	65
Total weight		kg	0.1	0.2	0.3	0.5	0.7	1.3	2.2	3.2	4.4	7.2	10.5

## Pins

Corrosion protection: 008 - 016 hot-dip galvanized, 020 - 120 spray-galvanized

Material: According to ETA-18/0878

Pin length	G	mm	29	34.5	40.5	45.5	52	65	70.5	78	90	99	116
Outer diameter	$\varnothing D_p$	mm	8	10	12	14	16	20	24	27	30	36	42

## Connection Plate

Material: S355

Min. width	$c_{min}$	mm	27	33	40	48	54	66	84	105	106	145	166
Plate thickness	t	mm	8	10	12	15	15	20	20	20	25	25	30
Diameter drilled hole	$\varnothing d_b$	mm	9	11	13.5	16	18	22	26	30	33	39	45
Edge distance	$f_{min}$	mm	14.5	17.5	21.5	26	29	35	42	48	53	62	72

## Fork End

Corrosion protection: hot-dip galvanized

Material: According to ETA-18/0878

Dimension	A	mm	26	32	39	47	53	66	77	88	98	115	133
Dimension	B	mm	10	12	14	17	18	23	23.5	23.5	28.5	28.5	34
Dimension	C	mm	21	25.6	31	36	40	51	56.5	61.5	70.5	79.5	94
Dimension	E	mm	18.5	22.5	27.5	32	37	45	54	60	65	76	86
Dimension	F	mm	14.5	17.5	21.5	26	29	35	42	48	53	62	72
Dimension	H	mm	40.5	50	60.5	73	80	100	120	134	147	174	201
Diameter inner thread	$\varnothing m$	mm	8	10	12	14	16	20	24	27	30	36	42

## Fork End UMIX

Size			048	052	056	060	064	070	080	090	100	110	120
Min. width	$c_{\min}$	mm	187	197	225	235	260	285	320	355	415	445	485
Plate thickness	t	mm	35	40	40	45	45	50	60	70	75	85	95
Diameter drilled hole	$\varnothing d_B$	mm	51	55	59	63	67	73	83	95	109	121	132
Edge distance	$f_{\min}$	mm	82	88	95	100	107	117	133	152	174	193	210

### Fork End

Corrosion protection: hot-dip galvanized

Material: According to ETA-18/0878

Dimension	A	mm	151	162	176	187	200	220	257	289	325	367	400
Dimension	B	mm	39	45	45	50	50	55	65	75	80	91	101
Dimension	C	mm	108	121	126	138	144	157	181	210	233	258	283
Dimension	E	mm	96	104	111	118	125	138	155	177	200	222	240
Dimension	F	mm	82	88	95	100	107	117	133	152	174	193	210
Dimension	H	mm	227	235	252	269	286	314	356	406	453	498	540
Diameter inner thread	$\varnothing m$	mm	48	52	56	60	64	70	80	90	100	110	120

# Spade End UMX



European technical assessment: ETA-18/0878

Installation: Please note installation manual!

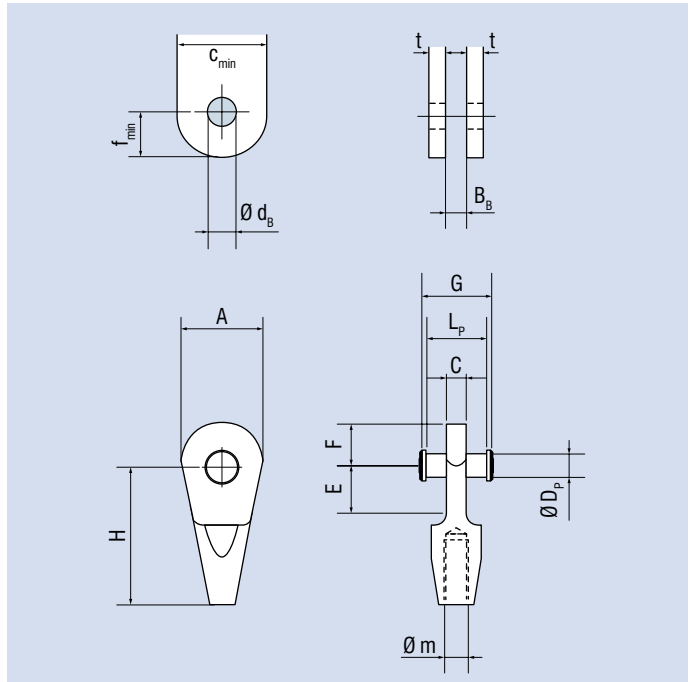

Size			008	010	012	014	016	020	024	027	030	036	042
Take-up	V	mm	± 4	± 5	± 7	± 9	± 9	± 11	± 14	± 16	± 17	± 21	± 25
Min. screw-in length		mm	13	17	20	23	25	32	38	42	47	56	65
Total weight		kg	0.09	0.17	0.3	0.52	0.7	1.39	2.02	2.97	4.27	6.58	10.55

## Connection Plate

Material: S355

Min. width	$c_{min}$	mm	25	31	38	45	53	66	78	88	98	115	135
Plate thickness	t	mm	5	6	8	8	10	12	15	18	20	25	25
Diameter drilled hole	$\varnothing d_B$	mm	9	11	13.5	16	18	22	26	30	33	39	45
Distance	$B_B$	mm	10	12	14	17	18	23	23.5	23.5	28.5	28.5	34
Edge distance	$f_{min}$	mm	14.5	17.5	21.5	26	29	35	42	48	53	62	72

## Spade End

Corrosion protection: hot-dip galvanized

Material: According to ETA-18/0878

Dimension	A	mm	25	31	38	45	53	66	78	88	98	115	135
Dimension	C	mm	8	10	12	15	15	20	20	20	25	25	30
Dimension	E	mm	17	21	25	29	33	40	48	54	59	66	78
Dimension	F	mm	15	18	22	26	29	35	42	48	53	62	72
Dimension	H	mm	48	59	71	86	93	117	141	159	173	205	240
Diameter inner thread	$\varnothing m$	mm	8	10	12	14	16	20	24	27	30	36	42

## Pins

Corrosion protection: 008 - 016 hot-dip galvanized, 020 - 120 spray-galvanized

Material: According to ETA-18/0878

Length pin	G	mm	29	34.5	40.5	45.5	52	65	70.5	78	90	99	116
Length pin shank	$L_p$	mm	24	28.5	34.5	39.5	44	55	60.5	66	76	85	100
Outer diameter	$\varnothing D_p$	mm	8	10	12	14	16	20	24	27	30	36	42



# Spade End UMIX

Size			048	052	056	060	064	070	080	090	100	110	120
<b>Spade End</b>													
Corrosion protection: hot-dip galvanized													
Material: According to ETA-18/0878													
Dimension	A	mm	153	163	175	186	199	217	254	288	321	371	394
Dimension	C	mm	35	40	40	45	45	50	60	70	75	85	95
Dimension	E	mm	87	94	100	106	112	124	139	159	180	200	216
Dimension	F	mm	82	88	95	100	107	117	133	152	174	193	210
Dimension	H	mm	270	283	305	320	343	375	422	482	539	584	640
Diameter inner thread	Øm	mm	48	52	56	60	64	70	80	90	100	110	120
<b>Pins</b>													
Corrosion protection: 008 - 016 hot-dip galvanized, 020 - 120 spray-galvanized													
Material: According to ETA-18/0878													
Length pin	G	mm	130	144	149	166	172	187	215	244	273	300	325
Length pin shank	L <sub>p</sub>	mm	114	128	133	146	152	167	191	220	245	272	297
Outer diameter	ØD <sub>p</sub>	mm	48	52	56	60	64	70	80	92	106	118	129

# Adapter UMIX



European technical assessment: ETA-18/0878

Installation: Please note installation manual!

Technical details: Dimensions without corrosion protection!

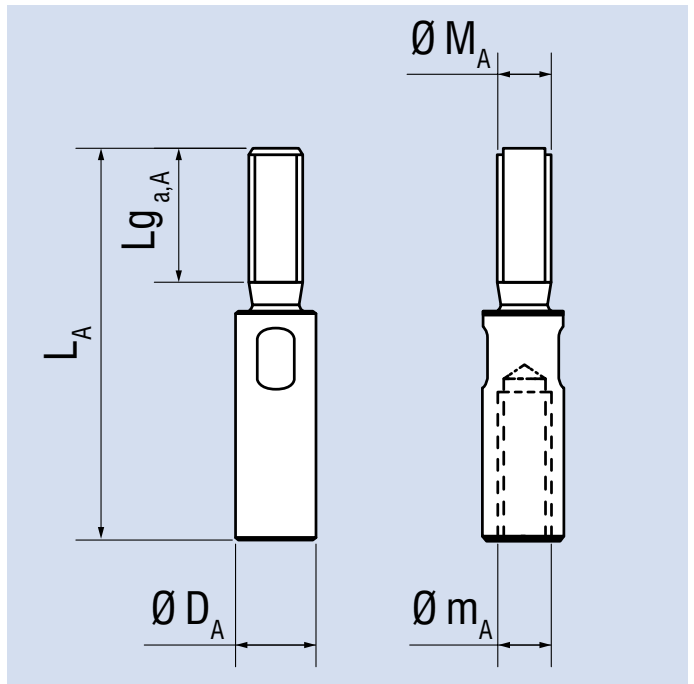

Size		008	010	012	014	016	020	024	027	030	036	042
Total weight	kg	0.03	0.06	0.1	0.16	0.22	0.44	0.76	1.1	1.5	2.2	3.6

## Adapter UMIX

Corrosion protection: hot-dip galvanized

Material: According to ETA-18/0878

Length	$L_A$	mm	60	74	89	107	113.5	144	172	191	214	242	283
Outer diameter	$\varnothing D_A$	mm	12	15	18	21	24	30	36	40.5	45	54	63
diameter inner thread	$\varnothing m_A$	mm	8	10	12	14	16	20	24	27	30	36	42
diameter outer thread	$\varnothing M_A$	mm	8	10	12	14	16	20	24	27	30	36	42
Length outer thread	$L_{g_{a,A}}$	mm	20	25	30	37	39	50	60	68	75	90	106

Size		048	052	056	060	064	070	080	090	100	110	120
Total weight	kg	5.4	6.7	8.3	9.9	12.5	16.5	24.6	35.2	47.9	62.8	81.3

## Adapter UMIX

Corrosion protection: hot-dip galvanized

Material: According to ETA-18/0878

Length	$L_A$	mm	322	336	362	380	412	459	520	586	643	691	750
Outer diameter	$\varnothing D_A$	mm	72	78	84	90	96	105	120	135	150	165	180
diameter inner thread	$\varnothing m_A$	mm	48	52	56	60	64	70	80	90	100	110	120
diameter outer thread	$\varnothing M_A$	mm	48	52	56	60	64	70	80	90	100	110	120
Length outer thread	$L_{g_{a,A}}$	mm	121	131	141	151	161	176	201	230	253	276	300

# Locking Nut UMIX



**European technical assessment:** ETA-18/0878

**Installation:** Please note installation manual!

**Technical details:** Dimensions without corrosion protection!

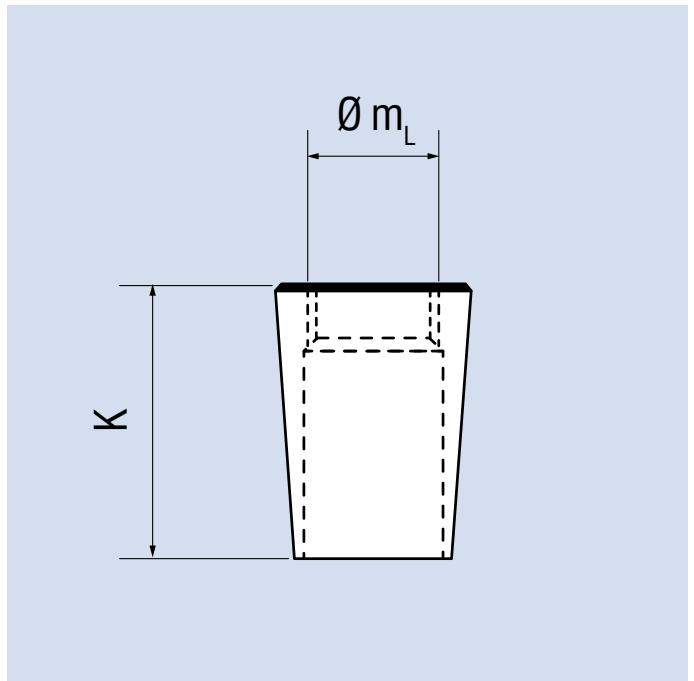

Size		008	010	012	014	016	020	024	027	030	036	042
Total weight	kg	0.01	0.01	0.02	0.03	0.04	0.08	0.14	0.19	0.26	0.42	0.67

## Locking Nut

Corrosion protection: hot-dip galvanized

Material: According to ETA-18/0878

Length	K	mm	17	21	25	31.5	33	42	50	55.5	62	73	86
Diameter inner thread	Øm <sub>L</sub>	mm	8	10	12	14	16	20	24	27	30	36	42

Size		048	052	056	060	064	070	080	090	100	110	120
Total weight	kg	1	1.3	1.6	2	2.4	3.1	4.6	6.5	8.5	11.2	14.4

## Locking Nut

Corrosion protection: hot-dip galvanized

Material: According to ETA-18/0878

Length	K	mm	98	105	113	119.5	127	138	155	175	190	205	220
Diameter inner thread	Øm <sub>L</sub>	mm	48	52	56	60	64	70	80	90	100	110	120





## Take ups – System with fork ends on both sides

### Tension rod system

L = system length ± take up

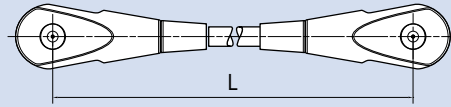

System size		8	10	12	14	16	20	24	27	30	36	42	48	52	56	60	64	70	80	90	100	110	120
Min. system length	mm	256	281	308	342	358	411	462	497	533	602	674	743	768	813	855	901	972	1077	1202	1316	1426	1530
Max. system length	mm	6046	6056	6069	6082	12092	12113	12136	12152	12165	12194	12222	12249	12270	12289	12307	12325	12358	12405	12462	12520	12574	12620
Take up (±)	mm	9	11	14	18	18	23	28	32	35	42	50	57	62	67	71	75	82	95	110	120	130	140

### Tension rod system with adapter

L = system length ± take up

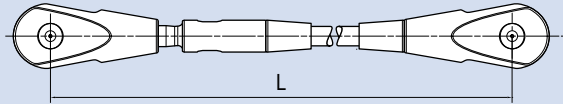

System size		8	10	12	14	16	20	24	27	30	36	42	48	52	56	60	64	70	80	90	100	110	120
Min. system length	mm	298,5	333	371	417	437,5	511,5	582	630	682,5	767	867	962,5	1004	1067,5	1119,5	1189,5	1296	1443,5	1613	1766	1906	2050
Max. system length	mm	6088,5	6108	6132	6157	12171,5	12213,5	12256	12285	12314,5	12359	12415	12468,5	12506	12543,5	12571,5	12613,5	12682	12771,5	12873	12970	13054	13140
Take up (±)	mm	13,5	16,5	21	27	27	34,5	42	48	52,5	63	75	85,5	93	100,5	106,5	112,5	123	142,5	165	180	195	210

### Tension rod system with connector

L = system length ± take up

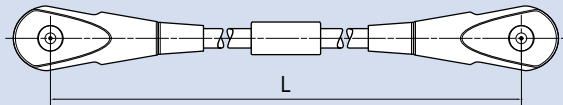

System size		8	10	12	14	16	20	24	27	30	36	42	48	52	56	60	64	70	80	90	100	110	120
Min. system length	mm	466	506	547	602	624	709	788	842	901	1010	1126	1237	1266	1337	1403	1477	1586	1749	1942	2112	2278	2440
Max. system length	mm	12046	12056	12069	12082	24092	24113	24136	24152	24165	24194	24222	24249	24270	24289	24307	24325	24358	24405	24462	24520	24574	24620
Take up (±)	mm	9	11	14	18	18	23	28	32	35	42	50	57	62	67	71	75	82	95	110	120	130	140

### Tension rod system with intersection coupler

L = system length ± take up

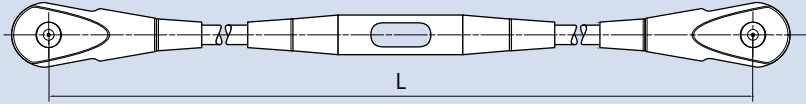

System size		8	10	12	14	16	20	24	27	30	36	42	48	52	56	60	64	70	80	90	100	110	120
Min. system length	mm	517	568	621	687	718	825	925	997	1072	1188	1335	1475	1526	1619	1706	1793	1930	2146	2392	2610	2824	3035
Max. system length	mm	12097	12118	12143	12167	24186	24229	24273	24307	24336	24372	24431	24487	24530	24571	24610	24641	24702	24802	24912	25018	25120	25215
Take up (±)	mm	18	22	28	36	36	46	56	64	70	84	100	114	124	134	142	150	164	190	220	240	260	280

### Tension rod system with coupler

L = system length ± take up

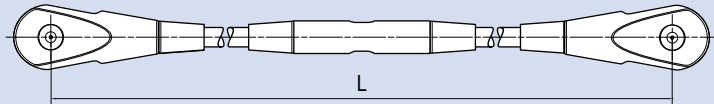

System size		8	10	12	14	16	20	24	27	30	36	42	48	52	56	60	64	70	80	90	100	110	120
Min. system length	mm	487	530	575	630	660	751	837	897	968	1088	1215	1338	1332	1410	1480	1557	1674	1850	2058	2238	2414	2586
Max. system length	mm	12067	12080	12097	12110	24128	24155	24185	24207	24232	24272	24311	24350	24336	24362	24384	24405	24446	24506	24578	24646	24710	24766
Take up (±)	mm	18	22	28	36	36	46	56	64	70	84	100	114	124	134	142	150	164	190	220	240	260	280

### Tension rod system with two couplers

L = system length ± take up

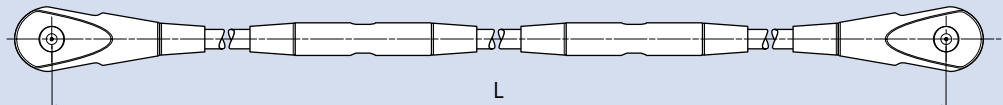

System size		8	10	12	14	16	20	24	27	30	36	42	48	52	56	60	64	70	80	90	100	110	120
Min. system length	mm	718	779	842	918	962	1091	1212	1297	1403	1574	1756	1933	1896	2007	2105	2213	2376	2623	2914	3160	3402	3642
Max. system length	mm	18088	18104	18125	18138	36164	36197	36234	36262	36299	36350	36400	36451	36402	36435	36461	36485	36534	36607	36694	36772	36846	36912
Take up (±)	mm	27	33	42	54	54	69	84	96	105	126	150	171	186	201	213	225	246	285	330	360	390	420

# Take ups – System with spade ends on both sides

## Tension rod system

L = system length ± take up

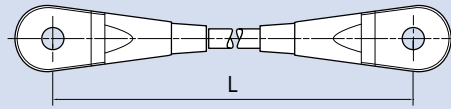

System size		8	10	12	14	16	20	24	27	30	36	42	48	52	56	60	64	70	80	90	100	110	120
Min. system length	mm	270	299	328	368	384	445	504	547	585	664	752	829	864	919	957	1015	1094	1209	1353	1488	1598	1730
Max. system length	mm	6060	6074	6089	6108	12118	12147	12178	12202	12217	12256	12300	12335	12366	12395	12409	12439	12480	12537	12613	12692	12746	12820
Take up (±)	mm	9	11	14	18	18	23	28	32	35	42	50	57	62	67	71	75	82	95	110	120	130	140

## Tension rod system with adapter

L = system length ± take up

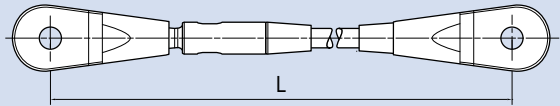

System size		8	10	12	14	16	20	24	27	30	36	42	48	52	56	60	64	70	80	90	100	110	120
Min. system length	mm	312,5	351	391	443	463,5	545,5	624	680	734,5	829	945	1048,5	1100	1173,5	1221,5	1303,5	1418	1575,5	1764	1938	2078	2250
Max. system length	mm	6102,5	6126	6152	6183	12197,5	12247,5	12298	12335	12366,5	12421	12493	12554,5	12602	12649,5	12673,5	12727,5	12804	12903,5	13024	13142	13226	13340
Take up (±)	mm	13,5	16,5	21	27	27	34,5	42	48	52,5	63	75	85,5	93	100,5	106,5	112,5	123	142,5	165	180	195	210

## Tension rod system with connector

L = system length ± take up

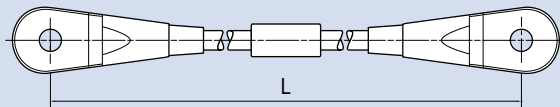

System size		8	10	12	14	16	20	24	27	30	36	42	48	52	56	60	64	70	80	90	100	110	120
Min. system length	mm	480	524	567	628	650	743	830	892	953	1072	1204	1323	1362	1443	1505	1591	1708	1881	2093	2284	2450	2640
Max. system length	mm	12060	12074	12089	12108	24118	24147	24178	24202	24217	24256	24300	24335	24366	24395	24409	24439	24480	24537	24613	24692	24746	24820
Take up (±)	mm	9	11	14	18	18	23	28	32	35	42	50	57	62	67	71	75	82	95	110	120	130	140

## Tension rod system with intersection coupler

L = system length ± take up

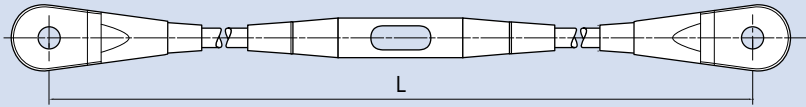

System size		8	10	12	14	16	20	24	27	30	36	42	48	52	56	60	64	70	80	90	100	110	120
Min. system length	mm	531	586	641	713	744	859	967	1047	1124	1250	1413	1561	1622	1725	1808	1907	2052	2278	2543	2782	2996	3235
Max. system length	mm	12111	12136	12163	12193	24212	24263	24315	24357	24388	24434	24509	24573	24626	24677	24712	24755	24824	24934	25063	25190	25292	25415
Take up (±)	mm	18	22	28	36	36	46	56	64	70	84	100	114	124	134	142	150	164	190	220	240	260	280

## Tension rod system with coupler

L = system length ± take up

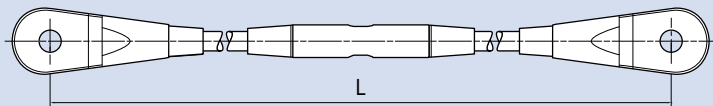

System size		8	10	12	14	16	20	24	27	30	36	42	48	52	56	60	64	70	80	90	100	110	120
Min. system length	mm	501	548	595	656	686	785	879	947	1020	1150	1293	1424	1428	1516	1582	1671	1796	1982	2209	2410	2586	2786
Max. system length	mm	12081	12098	12117	12136	24154	24189	24227	24257	24284	24334	24389	24436	24443	24468	24486	24519	24568	24638	24729	24818	24882	24966
Take up (±)	mm	18	22	28	36	36	46	56	64	70	84	100	114	124	134	142	150	164	190	220	240	260	280

## Tension rod system with two couplers

L = system length ± take up

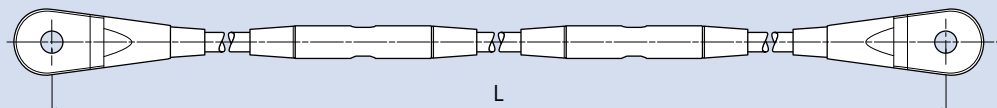

System size		8	10	12	14	16	20	24	27	30	36	42	48	52	56	60	64	70	80	90	100	110	120
Min. system length	mm	732	797	862	944	988	1125	1254	1347	1455	1636	1834	2019	1992	2113	2207	2327	2498	2755	3065	3332	3574	3842
Max. system length	mm	18102	18122	18145	18164	36190	36231	36276	36312	36351	36412	36478	36537	36498	36541	36563	36599	36656	36739	36845	36944	37018	37112
Take up (±)	mm	27	33	42	54	54	69	84	96	105	126	150	171	186	201	213	225	246	285	330	360	390	420

GERMANY

87700 Memmingen  
+49 (0) 83 31-937-117  
zuglieder@pfeifer.de

SWITZERLAND

8934 Knonau  
+41 (0) 44-7 68 55-55  
info@pfeifer-isofer.ch

POLAND

55-300 Krępiec  
+48 71 396 80 00  
office@pfeifer.pl

ASIA-PACIFIC

199567 Singapore  
+65 6908 2058  
info.pss@pfeifer.de

MIDDLE EAST

Dubai  
+971 48838445  
structure@pfeifer.ae

NORTH AMERICA

Dallas  
+1-416-237-9934  
isiotor@pfeifer.us.com